

TRANSFORMER DISCONNECT - NEMA 12 / IP54 GPFB SERIES

GENERAL PURPOSE (0.50 KVA - 3 KVA)

The Daykin GPFB Series is a NEMA 12 / IP54 enclosed transformer disconnect suitable for mounting on the outside of an electrical control panel. This enclosure has provisions for base or side mounting. Dual mounting capability offers flexibility.

Features

- 200 kA RMS short circuit current rating
- Lockable switch in the off position with primary integral CLASS CC fuses
- Secondary fuseholders only - suitable for 13/32" x 1 1/2" fuses
- Electrostatically shielded transformer provides positive protection against short circuits from the primary to the secondary, as well as attenuating high frequency noise and transients
- Continuous hinged door with neoprene gasketing and enclosure seams continuously welded
- Power-on pilot light
- Optional covered GFCI protected receptacles
- For control circuits only
-  Listed

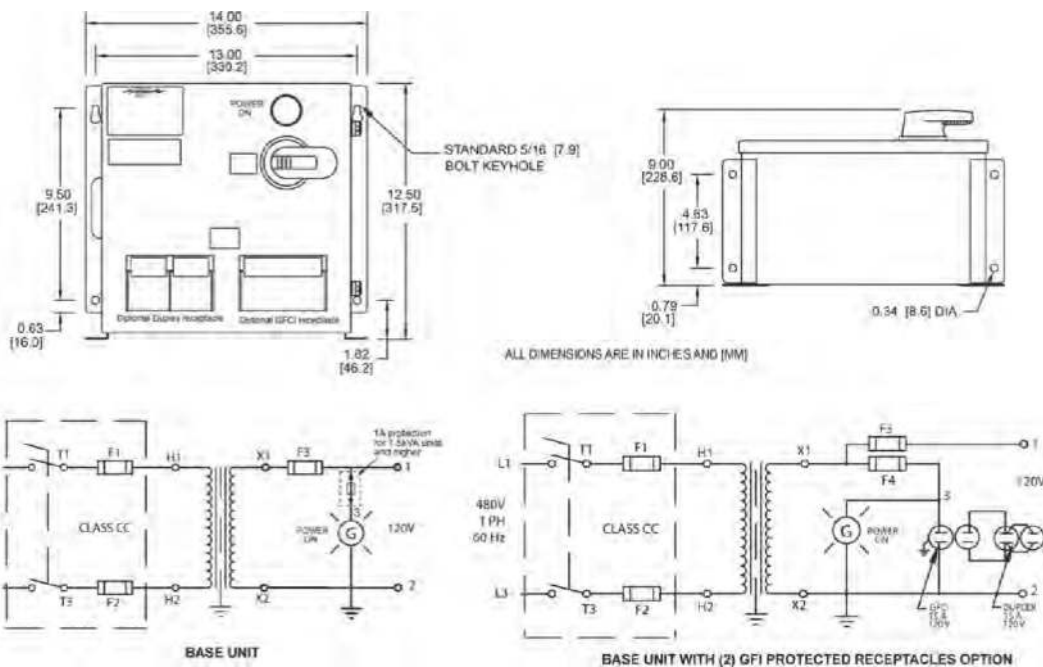

Transformer kVA Rating	Model	Fuse Rating/Amps		Approx. Weight lb (kg)
		Primary	Max. Secondary	
		F1 & F2	F3 & F4	
0.5	GPFB-0.5	3	6	39 (18)
1.0	GPFB-1	6	12	44 (20)
1.5	GPFB-1.5	12	20	56 (25)
2.0	GPFB-2	12	25	60 (27)
3.0	GPFB-3	15	30	66 (30)

Note: Secondary fuses are not provided

GrandPowerSystems.com • Ph: (844) 383-8644 • sales@daykin.com







by

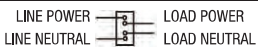

TRANSFORMER DISCONNECTS

OPTIONS AVAILABLE FOR TRANSFORMER DISCONNECTS

General Options Available	Add Suffix
Standard duplex receptacle (with fuseholder only) 	D
Secondary fuses provided	F
GFCI receptacle provided (with fuseholder only) 	G
GFCI breaker to protect entire load 	B
European “S hukō “ style receptacle 2P, 3W, 250V (with fuseholder only) 	M
Universal receptacle provided (with fuseholder only) 	R
No pilot light (pilot light is provided by default)	N
CE Certified	CE
3 primary fuses provided (2 provided by default)	P

VOLTAGE OPTIONS			
Primary Volts	Secondary Volts	Hertz	Add Suffix
240	120	60	240
380	115	50	380
400	115	50	400
415	115	50	415
600	120	60	600
380	220	50	3802
400	220	50	4002
415	220	50	4152
480	240	60	4801
480/380	120	50	431
480/380	220	50	432

Foot Notes:

- (1) For outputs greater than 20A, secondary fuseholder (supplied without fuse) must be added.
- (2) Options “D” and “G” are not available with these voltage combinations: must use options “M” or “R” if receptacle is required.
- (3) Cannot use standard receptacle on NEMA 12 enclosed units, due to potential outside installation; must use GFCI receptacle.
- (4) Options “D” and “G” may not be able to be installed in all units together.
- (5) More than 3 options, and certain combinations (“A” with 600VAC), will require a special part number. Please contact Customer Service to obtain part number for ordering purposes.
- (6) Units using a European “Shuko” or universal receptacle cannot be marked UL.

GrandPowerSystems.com • Ph: (844) 383-8644 • sales@daykin.com



by

